

# LED Tri-proof Light Installation

## 1. Product Size

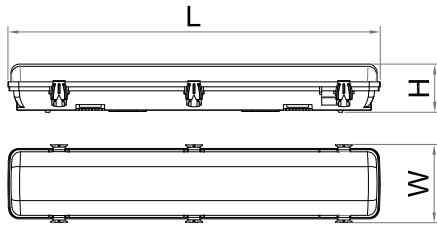

Type	Size L	Size W	Size H	Size L1	Size L2
2FT	650.0mm	130.0mm	85.0mm	362mm	170mm
4FT	1270.0mm	130.0mm	85.0mm	840mm	240mm
5FT	1560.0mm	130.0mm	85.0mm	892mm	360mm
6FT	1865.0mm	162.0mm	110.0mm	1135mm	400mm

## 2. Surface mounting procedure

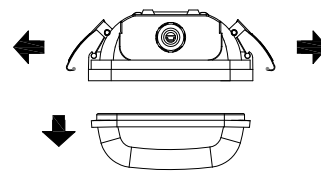
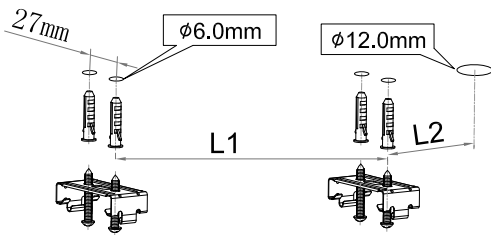

1). Seat the fixing clips to the mounting surface according to the dimension instruction.

2). Open the two sides spring clips of the lamp, remove the lamp cover.

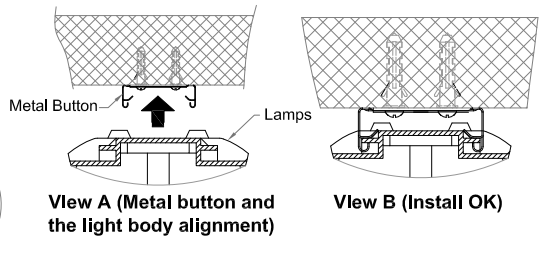
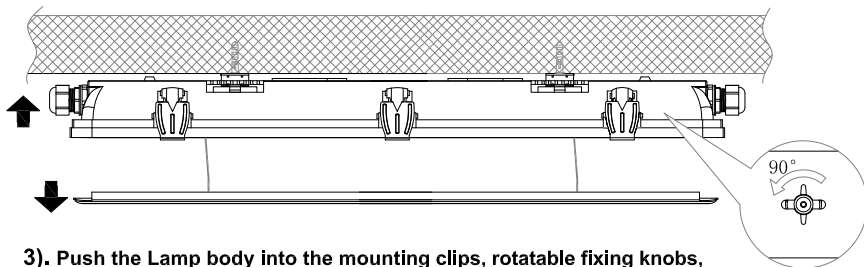

3). Push the Lamp body into the mounting clips, rotatable fixing knobs, remove PCB mounted plate.

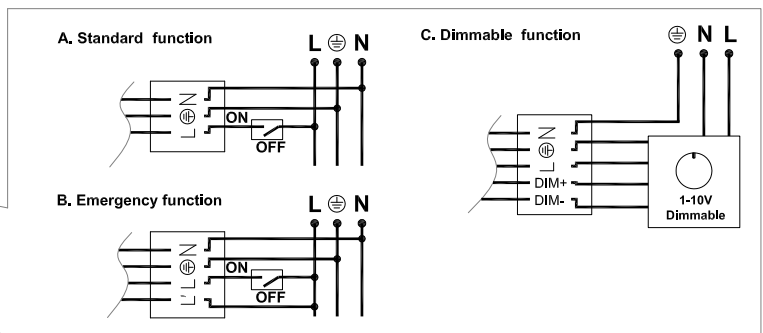
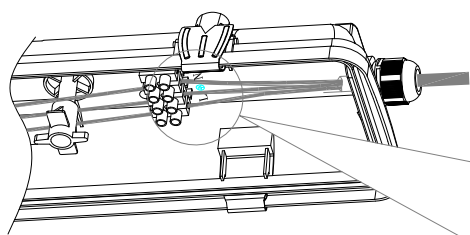

4). Turn off the power and connect the two ends input wires then tighten waterproof connector.

## 3. Parts included

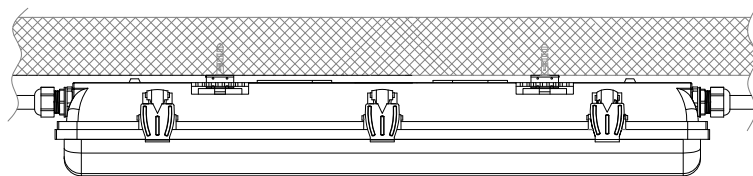

5). Assemble PCB mounted plate, lamp cover, installation finished.

